

TaHoma® switch

Smart control system

The smart control system to centralise and connect your home equipment

PRODUCTS MAIN FUNCTIONALITIES



Compatible with multiple technologies: Zigbee 3.0, Somfy RTS + Cloud internet (Wi-Fi or Bluetooth)



Natively connects via WiFi; with option to connect via ethernet [adaptor required]



Open and scalable smart control system which can be integrated with Somfy and other leading third-party products



Creates up to 40 standard scenes + 20 timed scenes + 20 advanced scenes



Convenient control whether you're home or away



Centralised control using app or voice control (when paired with compatible smart devices)



Bi-directional feedback, battery level monitoring for Somfy Zigbee motors & products



Activate your 2 favourite daily routines from the top of the hub



TaHoma pro app and Serve-Go tools available (onsite and offsite installation and maintenance)



COMPATIBLE END PRODUCTS

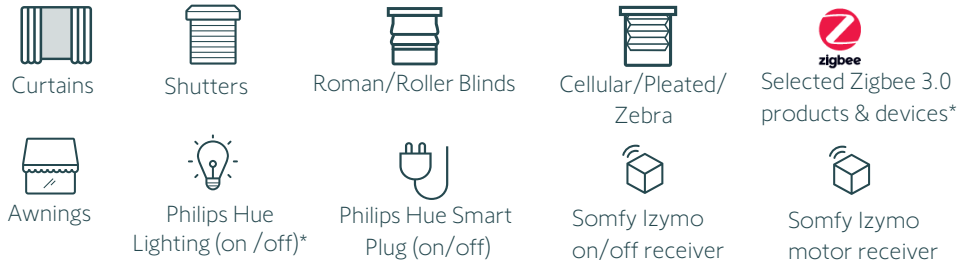

TaHoma® switch
Smart control system

BENEFITS FOR PROFESSIONALS

Intuitive and easy to install and set up

- Step-by-step instructions within the application to support a seamless and efficient hub set up
- Installer TaHoma pro app and Serv-e-Go tools available for error free pre-setup, as well as efficient onsite or offsite installation and maintenance
- Natively connects via WiFi; with option to connect via ethernet cable [adaptor required]

DIMENSIONS OF THE HUB

L1	162mm
L2	67mm
L3	35mm

ITEM NUMBERS

TaHoma switch hub	1871147
Ethernet adaptor for TaHoma switch <i>(optional extra)</i>	9028054

BENEFITS FOR END USERS

Open and scalable control system

- Can be integrated with Somfy and other leading third-party Zigbee 3.0 products
- Allows voice control with Amazon Alexa, Google Home, and Apple HomeKit (where applicable)
- Centralised control via an app or voice control
- Capable of controlling up to 125 end products (comprising of Somfy RTS products and compatible Zigbee 3.0 products and equipment)

Smart, intuitive and easy to use:

- Bi-directional feedback, battery level monitoring for Somfy Zigbee motors & compatible products
- Convenient control whether you are home or away
- Set up a variety of scenes and scheduled timers to create your ideal ambience, simplify your daily routines and personalise your environment

BOX INCLUSIONS

- 1 x TaHoma switch hub
- 1 x USB power adaptor
- 1 x USB power cable
- 1 x TaHoma switch set up leaflet
- 1 x legal security notice
- 1 x Apple HomeKit set up leaflet

Front View



Top View



Side View



USB power cable



USB power adaptor



Ethernet adaptor
(optional extra)



* Requires a Philips Hue bridge. Refer to partnerships and compatibilities.

TAHOMA SWITCH FUNCTIONS & CAPABILITIES

	Max
Number of Zigbee 3.0 products per hub	45 actuators** + 10 remotes
Number of Somfy RTS products per hub	50
Number of manual scenes per hub	40
Number of customised scenes controlled through the scene launcher push buttons	2
Number of advanced scenes per hub (Scenes which incorporate Zigbee 3.0 sensors)	20
Number of timers/scheduled scenes (Includes Sunrise & Sunset functions)	20
Number of hubs per profile	1
Number of TaHoma profiles which can be accessed in the app without logging off	3
Voice control compatibility	Google Assistant, Amazon Alexa, Apple HomeKit (where applicable)
Philips Hue Lighting	1 Bridge + 50 Lamps
Sonos	1 account + 200 devices
Languages	24 Languages available <i>[Refer to TaHoma by Somfy App]</i>

TaHoma switch Applications & Systems



End User App



TaHoma

Installer App*



Pro

**Available from July 2023*

**Actuators includes Somfy Zigbee motors & Philips Hue Smart plugs

PARTNERSHIPS AND COMPATIBILITIES



COMPATIBLE HOME AUTOMATION SYSTEMS (FROM Q1'2024)



TECHNICAL SPECIFICATIONS HUB

Frequency & Protocols	Zigbee 3.0 [2.4GHz] Somfy RTS [433 MHz] WiFi [2.4GHz]
Power	2A at 5V
IP Rating	IP30 - Indoor use only
Power Supply	230V
Working Temperature	0°C to 40°C
RCM Compliance	RCM & EESS Certification
Range (open field)	7m for Zigbee 3.0 protocol 20m for Somfy RTS protocol
Compatible operating software	iOS version: iOS 13 or greater Android version: 9.0 or greater
Devices	Compatible with smartphones & tablets

Voice Assistant compatibility



With selected Zigbee technology

DETAILED FUNCTIONING

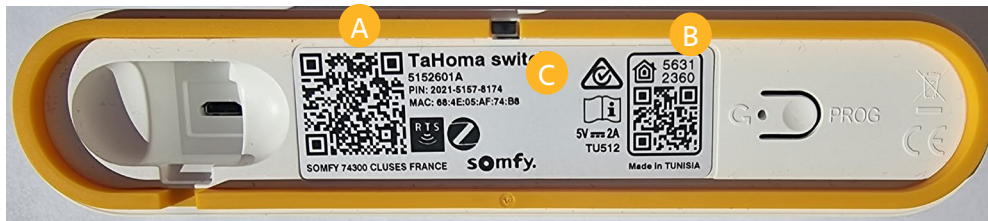

- A** QR Code to download the 'TaHoma' app
- B** QR Code for quick-start pairing and set up to 'Apple HomeKit (where applicable)
- C** TaHoma switch hub unique box PIN to support hub identification and troubleshooting

CONNECTIONS AND INDICATORS



Top LED

Scene Status	Indicator Colour/ State	Duration
Wi-Fi research	Blinking white 2 times	
Wi-Fi lost	Blinking 1 time	
Standby	Off	
Scene launched	Slow blinking white	3 sec.
Scene stopped (via stop button)	Solid red	<1 Sec.

Bottom LED

TaHoma switch State	Indicator Colour/ State	Duration
	Colour	State
Box not powered	None	Off
Box powered and not connected to server	Red	Solid on
Box powered and connected to server	White	Solid on (<i>can be deactivated</i>)

Top indicator is used for **SCENE MANAGEMENT**.

The top indicators are also used:

- For Wi-Fi setting process (blinking blue) + connection outage (blinking red)
- As a restart indicator (orange)
- As an indicator for TaHoma pro mode activation, using the new TaHoma pro app (green)

STANDARD use for power and server connection status

SETTING UP TAHOMA SWITCH WITH ETHERNET ADAPTOR (optional extra/sold separately)

The TaHoma Ethernet Adaptor [9028054] adds an ethernet LAN port to a TaHoma hub, providing a fast and stable internet connection. Ethernet cable not included.



TECHNICAL SPECIFICATIONS

Input Power	Micro USB Female: 5V, 2A (max)
Output Power	Micro USB Male: 5V, 2A (max)
Number of Ports:	(Downlink Port) RJ45 + Micro B Female (UpLink Port) RJ45 + Micro B Male
Transmission Speed:	10/100Mbps)
Working Temperature	0°C to 60°C
Dimensions (mm):	H: 186.94, L: 35.31, W: 17.02

WIRING INSTRUCTIONS

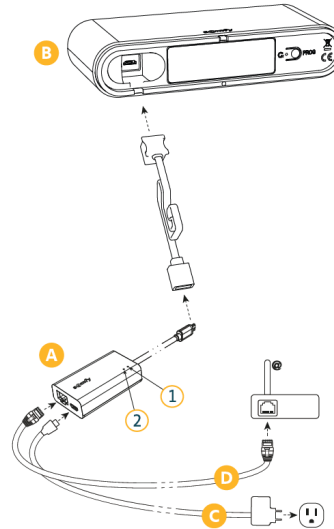

- A** Ethernet adaptor
- 1** Yellow light indicates data transfer
- 2** Blue light indicates ethernet connection
- B** TaHoma switch
- C** USB power supply
- D** Ethernet cable (not included in box)

NAVIGATING TAHOMA SWITCH END USER APP

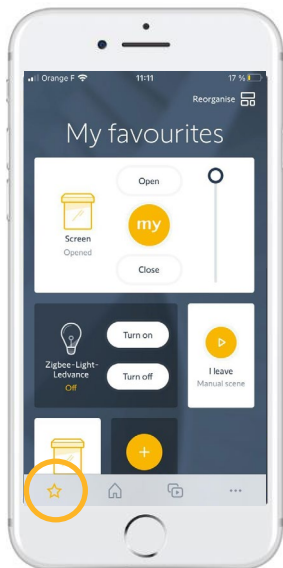

My Favourites

Centralise all your favourite motorised solutions, rooms or scenes on 1 tab. Customise the display and functions of each of your shortcuts to build a personalised menu.

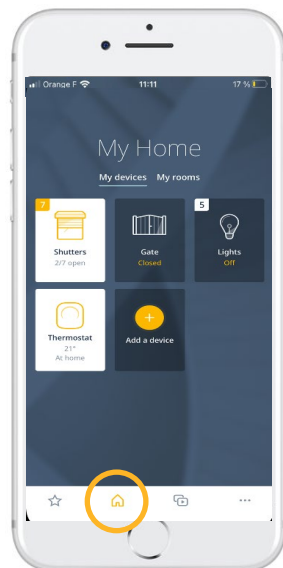

My Home

Access and operate all your equipment in a centralised tab in just one click. Operate your equipment by device or by room; the choice is yours.

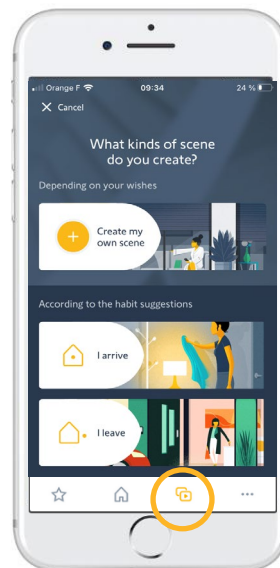

My Scenes

Personalise your home by creating scenes to create your ideal ambience or to save your time. Launch your scene in one click, or program a scene according to your routines and habits (schedule/timers).

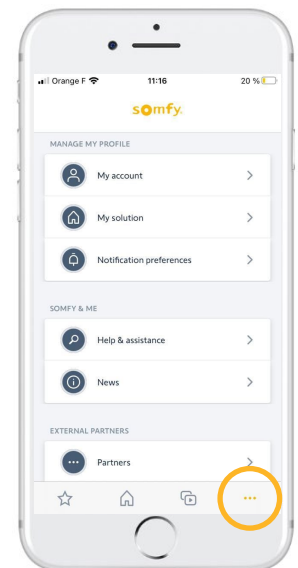

More

Access and manage general settings, preferences and third-party integrations.

INSTALLATION GUIDES AND TOOLS:

Help me by Somfy app



The only application that guides installers step-by-step when commissioning all Somfy products and lets them do without a paper manual, whatever the configuration they are working on.

TAHOMA SWITCH PRE-INSTALL CHECKLIST

For a seamless set up, please ensure:

1. All Somfy (RTS and Zigbee) motors and compatible equipment are fully charged.
2. Somfy RTS motor set-up is complete – pair remote controls, set motor end-limits and 'my' position.
3. Your internet router is active and operational (TaHoma® switch only operates with 2.4GHz (4G) WiFi).
4. WiFi network must be private/secured with a password.
5. An active email address to create a TaHoma® switch account is required. It cannot be the same email address used with an existing Connexoon Window RTS.
6. Ensure you have downloaded and set up an account with all third-party compatible applications on your smart device.
7. For Zigbee devices, have your motor and Ysia control QR code ready, prior to pairing your Zigbee motor, TaHoma® switch and motor limit settings.
8. Installation tip for building Zigbee mesh network: for a seamless set up, pair any plugs/wired Zigbee motors first. Then set up WireFree Zigbee motors, followed by any remotes.

TROUBLESHOOTING

Where can I find my TaHoma switch pin code?

On the underside of your TaHoma switch hub. Refer to diagram on page 4 of this document.

How can I log out of my TaHoma Account?

Click on the 'more' tab, scroll to the bottom, select log out/disconnect. Note: if you log out of the TaHoma app, all your 'favourites' settings will not be saved.

How can I add another registered TaHoma email?

Click on the 'more' tab, select 'add facility'. Follow the instructions/prompts.

My TaHoma hub has lost WiFi internet connection. How can I re-configure the WiFi internet connection?

Hold the 'stop' push button on the top of your TaHoma hub until the LED light blinks blue. Go to the 'more' tab in your TaHoma app. Select 'configuration of the installation'. Select 'My installation hub'. Select 'Configure WiFi'. Choose the WiFi network (ensuring the WiFi internet is 2.4GHz (4G)), enter the WiFi password. Note: an app update maybe required/prompted.